

# ADD/MODIFY BRACING – Main Features

Modified on: Tue, 17 Sep, 2019 at 9:53 PM

## Add/Modify Bracing

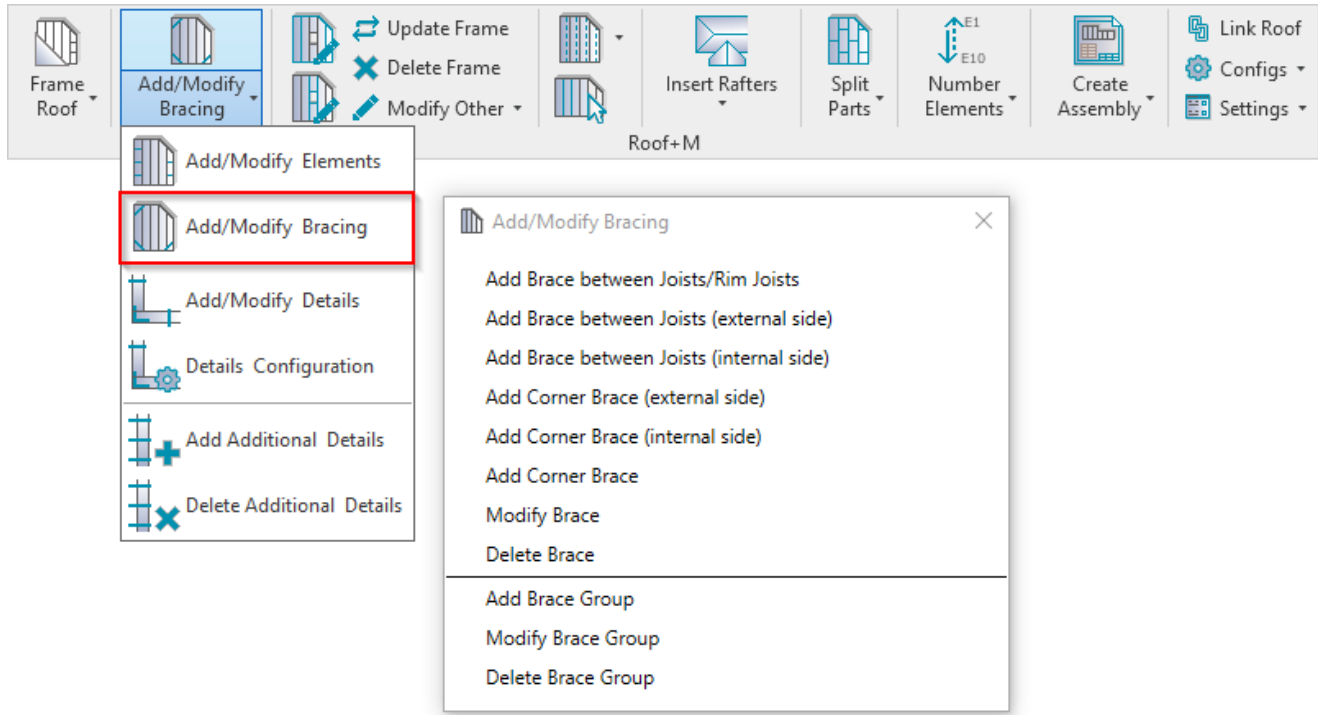

**Add/Modify Bracing** – features for adding/modifying braces between joists or rim joists, corner braces and brace groups.

## Add Brace between Joists/Rim Joists

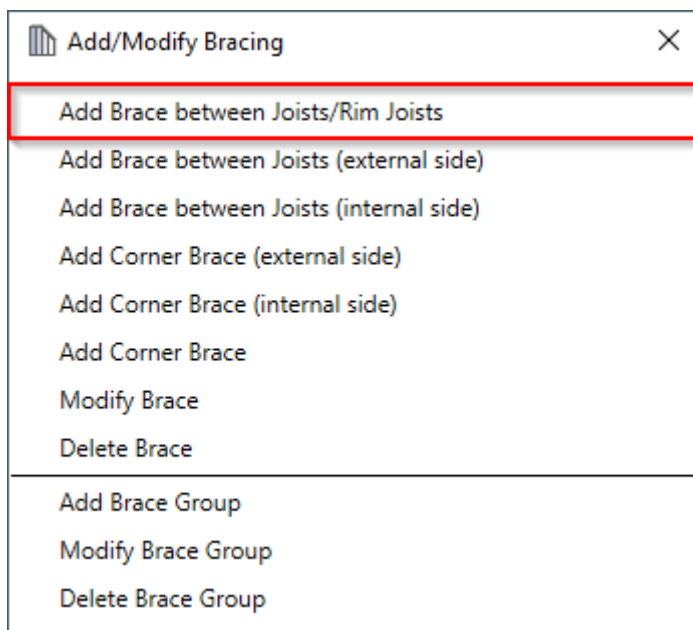

**Add Brace between Joists/Rim Joists** – adds a brace between two selected joists/rim joists on external or internal side of framing. To modify brace settings go to **Roof+M** → **Add/Modify Elements** → **Add/Modify Bracing** → **Modify Brace**.

*Example: Select a bottom rim joist and a top rim joist to show where bracing should end. Points selected should be as close as possible to where you want the bracing ends to actually be. (I.e. If you generically select a bottom rim joist and top rim joist, bracing might not be placed where you actually want it, so select the points precisely where you want the bracing to be placed.)*

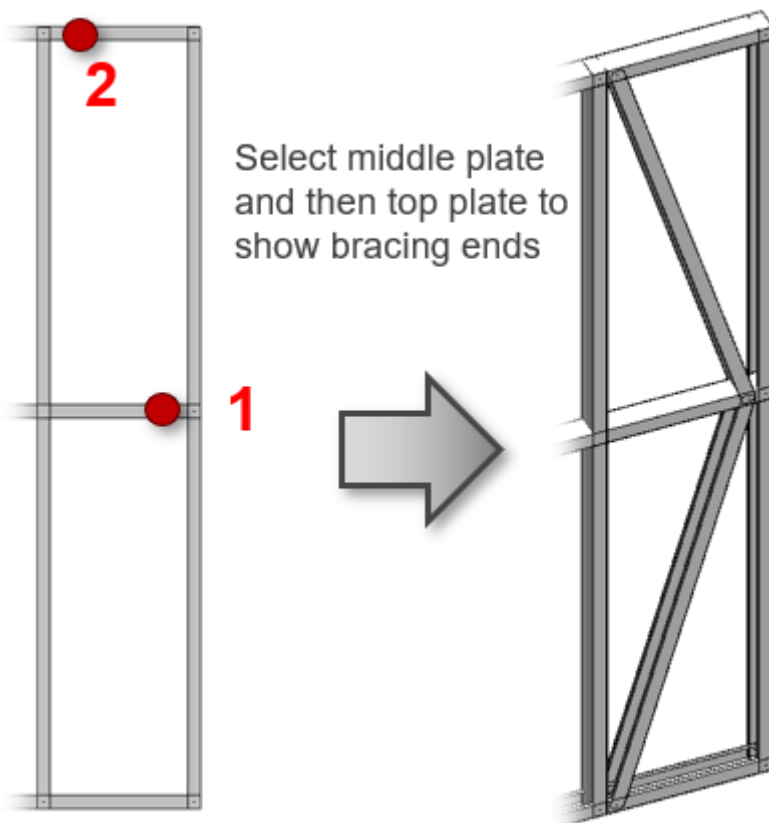
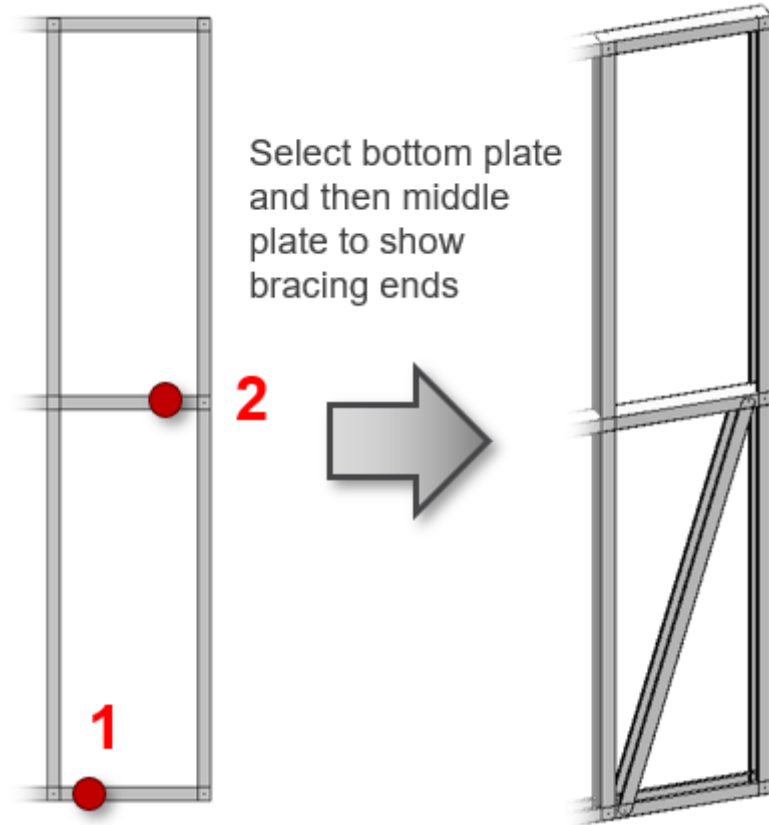

## Add Brace between Joists (external/internal side)

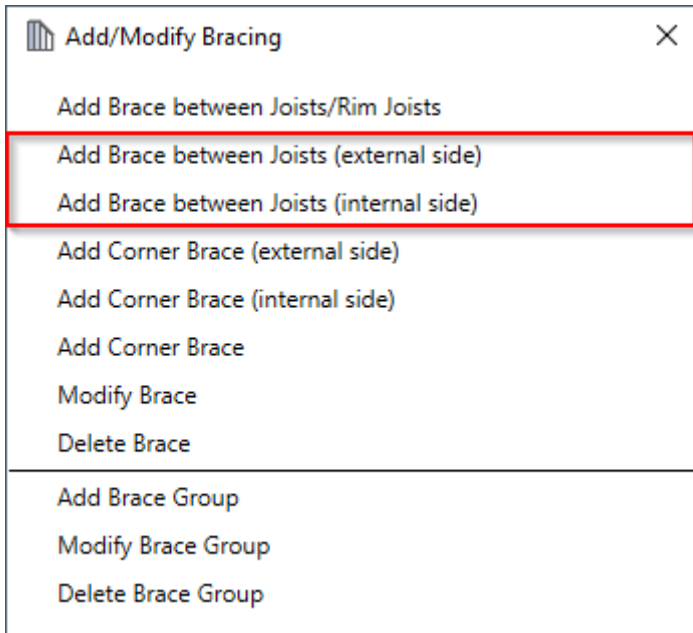

**Add Brace between Joists (external/internal side)** – adds a brace between two selected joists on external or internal side of framing. To modify brace settings go to **Roof+M** → **Add/Modify Elements** → **Add/Modify Bracing** → **Modify Brace**.

Default families for bracing are **I\_MF Strap.rvt** (in Imperial projects) and **M\_MF Strap.rvt** (in Metric projects).

*Example: Select a bottom rim joist and a top rim joist to show where bracing should end. Points selected should be as close as possible to where you want the bracing ends to actually be. (I.e. If you generically select a bottom rim joist and top rim joist, bracing might not be placed where you actually want it, so select the points precisely where you want the bracing to be placed.*

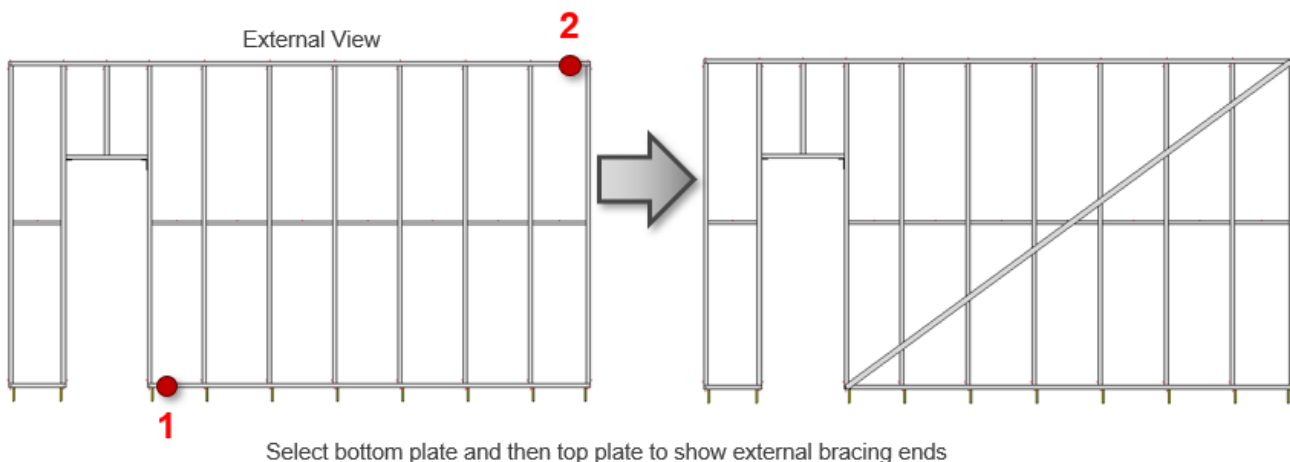

## Add Corner Brace (external/internal side)

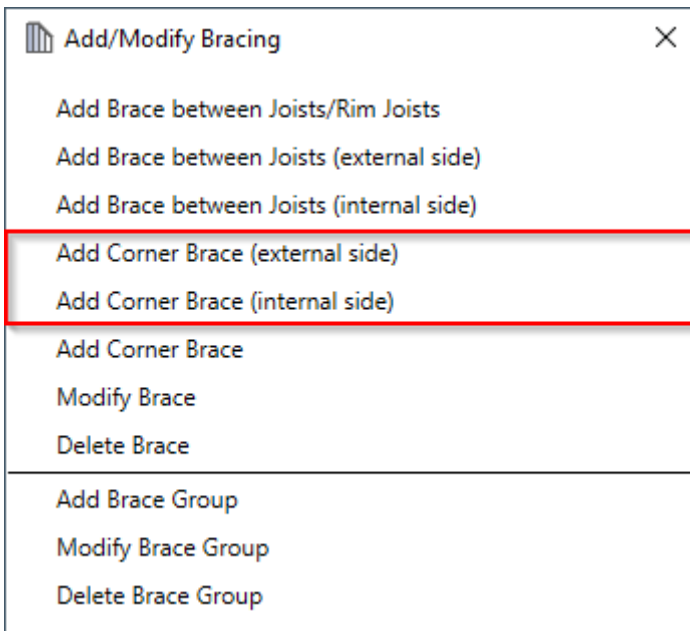

**Add Corner Brace (external/internal side)** – adds a corner brace between a selected rim joist and joist on external or internal side of framing. To modify brace settings go to **Roof+M** → **Add/Modify Elements** → **Add/Modify Bracing** → **Modify Brace**.

*Example: Select a bottom rim joist and then a joist to show where corner bracing ends should be. Points selected should be as close as possible to where you want the bracing ends to actually be. (I.e. If you generically select a bottom rim joist and a joist, bracing might not be placed where you actually want it, so select the points precisely where you want the bracing to be placed.*

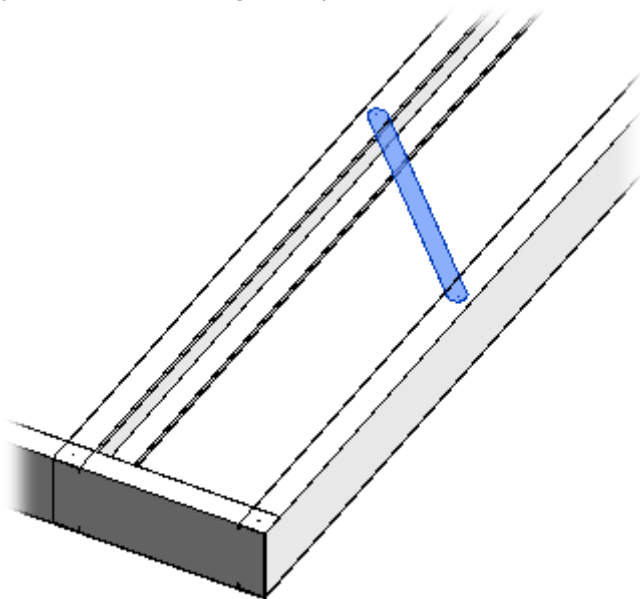

## Add Corner Brace

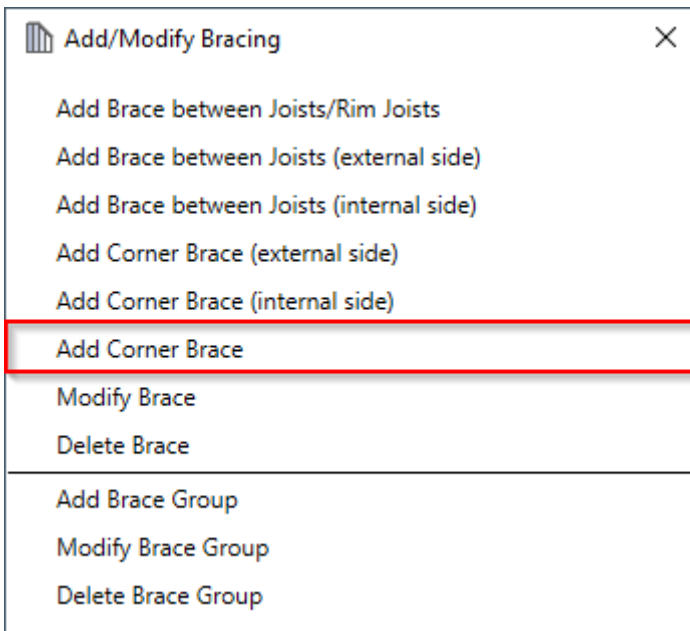

**Add Corner Brace** – adds a corner brace between a rim joist and a joist. To modify brace settings go to **Roof+M** → **Add/Modify Elements** → **Add/Modify Bracing** → **Modify Brace**.

*Example: Select a rim joist and then a joist to show where corner bracing ends should be. Points selected should be as close as possible to where you want the bracing ends to actually be. (I.e. If you generically select a rim joist and a joist, bracing might not be placed where you actually want it, so select the points precisely where you want the bracing to be placed.*

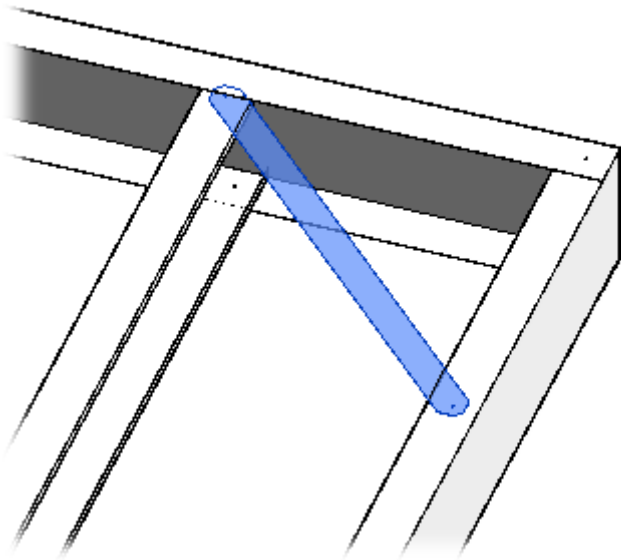

## Modify Brace

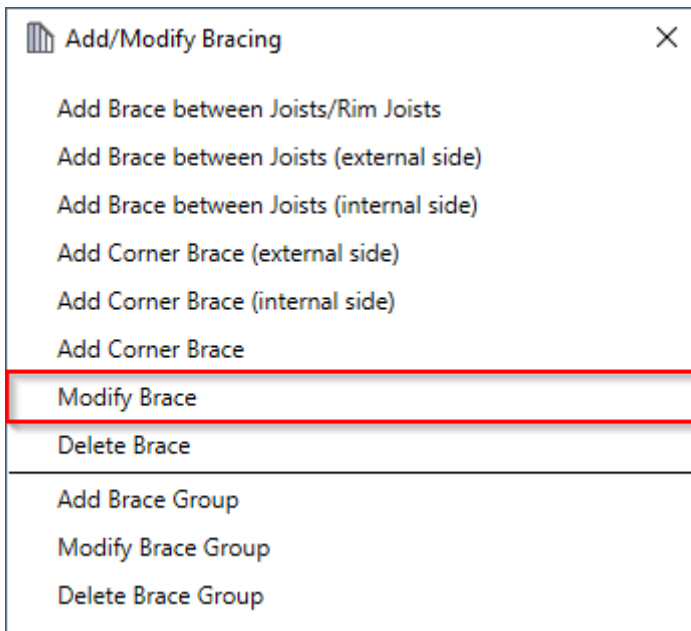

**Modify Brace** – modifies selected brace in the frame.

**Read more >>** (<https://agacad.freshdesk.com/support/solutions/articles/44001799399-add-modify-bracing-%E2%80%93-modify-brace>).

## Delete Brace

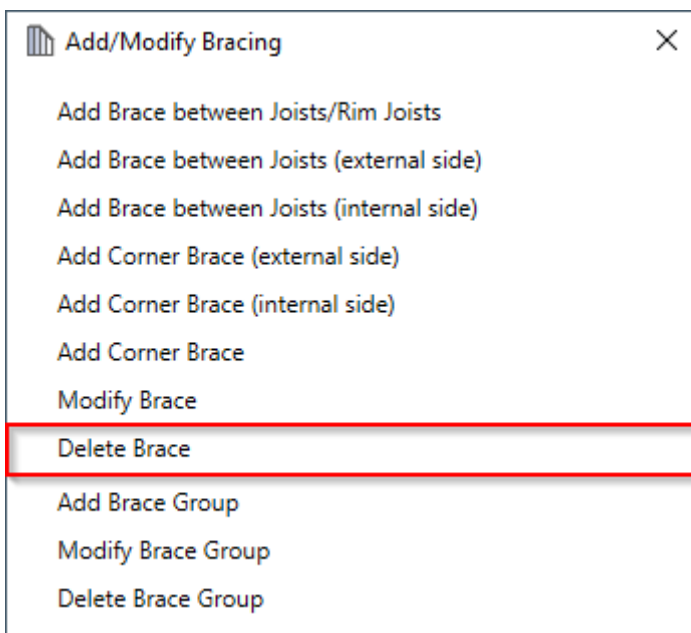

**Delete Brace** – deletes selected brace(s) from the frame.

You can choose **Delete Brace** and then select braces one-by-one or select all braces from the frame and then click **Delete Brace**.

## Add Brace Group

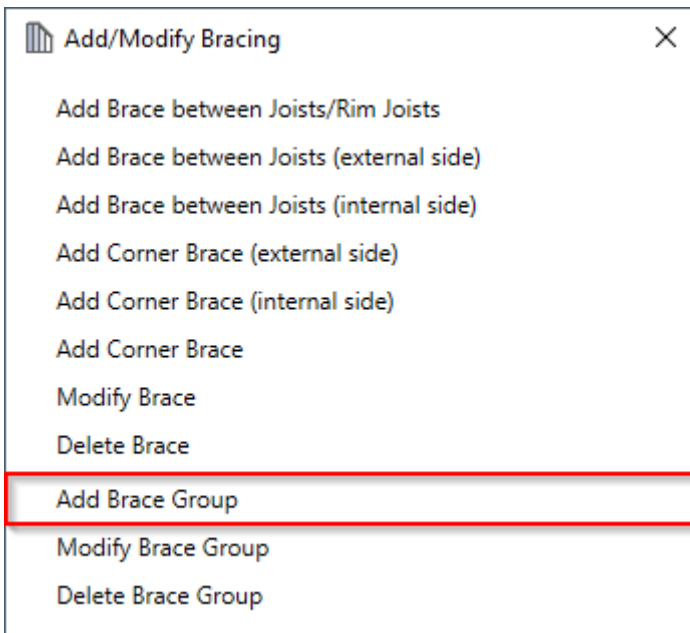

**Add Brace Group** – places short braces automatically between two joists with predefined rules.

*Example: Braces are added automatically between two selected joists.*

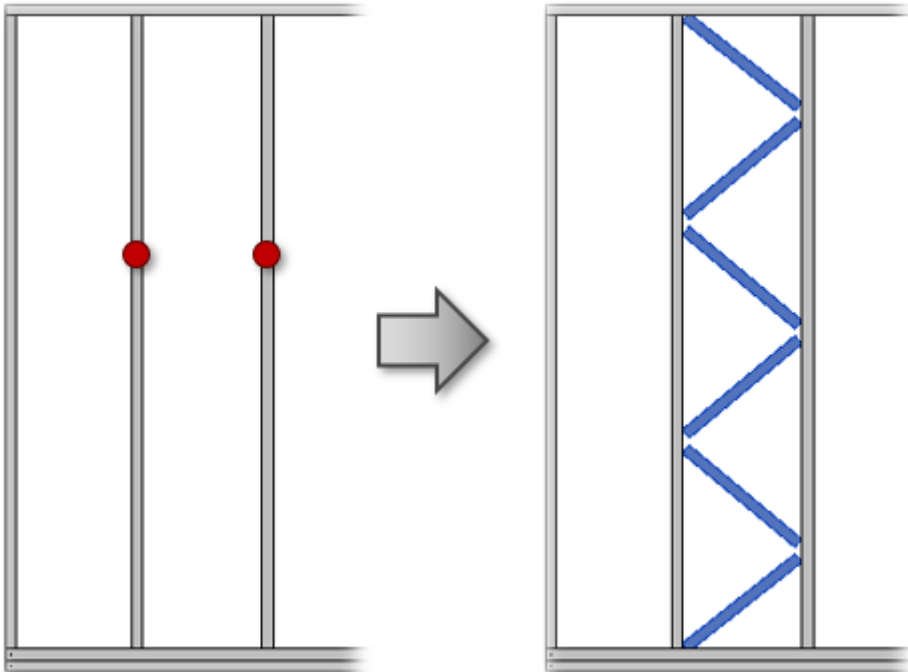

## Modify Brace Group

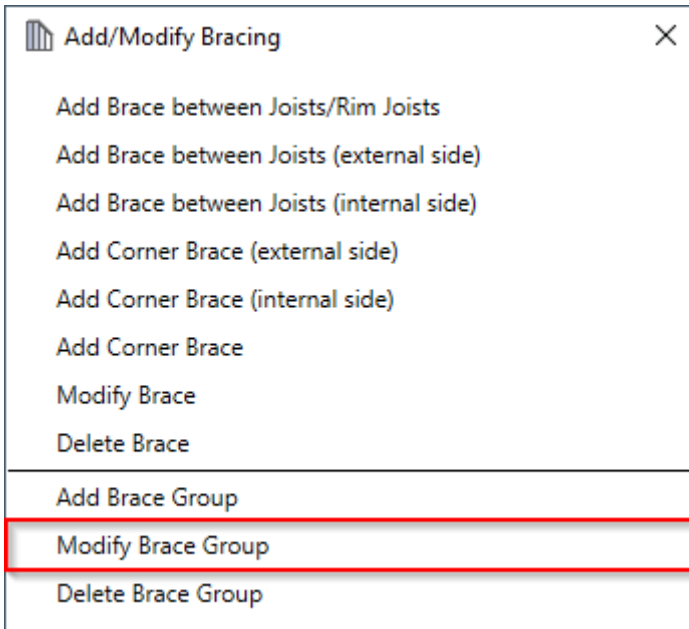

**Modify Brace Group** – modifies selected brace group in the frame.

**Read more >>** (<https://agacad.freshdesk.com/support/solutions/articles/44001799403-add-modify-bracing-%E2%80%93-modify-brace-group>).

## Delete Brace Group

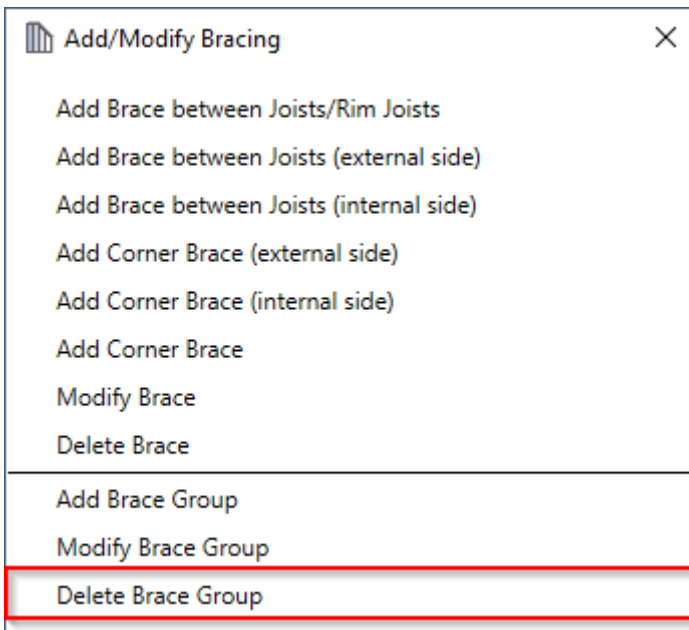

**Delete Brace Group** – deletes selected brace group from the frame.

*Example: You just need to select any element from the group and all elements will be deleted.*



